

BCP53

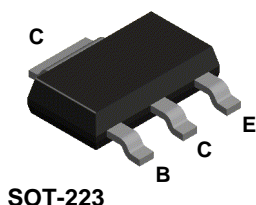

PNP General Purpose Amplifier

This device is designed for general purpose medium power amplifiers and switching circuits requiring collector currents to 1.0 A. Sourced from Process 78. See BCP52 for characteristics.

Absolute Maximum Ratings*

TA = 25°C unless otherwise noted

| Symbol | Parameter | Value | Units |
|-----------------------------------|--|-------------|-------|
| V _{CEO} | Collector-Emitter Voltage | 80 | V |
| V _{CB0} | Collector-Base Voltage | 100 | V |
| V _{EBO} | Emitter-Base Voltage | 5.0 | V |
| I _c | Collector Current - Continuous | 1.2 | A |
| T _J , T _{stg} | Operating and Storage Junction Temperature Range | -55 to +150 | °C |

*These ratings are limiting values above which the serviceability of any semiconductor device may be impaired.

NOTES:

- 1) These ratings are based on a maximum junction temperature of 150 degrees C.
- 2) These are steady state limits. The factory should be consulted on applications involving pulsed or low duty cycle operations.

Thermal Characteristics

TA = 25°C unless otherwise noted

| Symbol | Characteristic | Max | Units |
|------------------|---|-------|-------|
| | | BCP53 | |
| P _D | Total Device Dissipation Derate above 25°C | 1.5 | W |
| | | 12 | mW/°C |
| R _{θJA} | Thermal Resistance, Junction to Ambient | 83.3 | °C/W |

PNP General Purpose Amplifier
(continued)

BCP53

Electrical Characteristics

TA = 25°C unless otherwise noted

| Symbol | Parameter | Test Conditions | Min | Max | Units |
|--------|-----------|-----------------|-----|-----|-------|
|--------|-----------|-----------------|-----|-----|-------|

OFF CHARACTERISTICS

| | | | | | |
|---------------|-------------------------------------|---|-----|-----------|---------------------|
| $V_{(BR)CEO}$ | Collector-Emitter Breakdown Voltage | $I_C = 10 \text{ mA}, I_B = 0$ | 80 | | V |
| $V_{(BR)CBO}$ | Collector-Base Breakdown Voltage | $I_C = 100 \text{ }\mu\text{A}, I_E = 0$ | 100 | | V |
| $V_{(BR)EBO}$ | Emitter-Base Breakdown Voltage | $I_E = 10 \text{ }\mu\text{A}, I_C = 0$ | 5.0 | | V |
| I_{CBO} | Collector-Cutoff Current | $V_{CB} = 30 \text{ V}, I_E = 0$ $V_{CB} = 30 \text{ V}, I_E = 0, T_A = 125^\circ\text{C}$ | | 100 10 | nA μA |
| I_{EBO} | Emitter-Cutoff Current | $V_{EB} = 5.0 \text{ V}, I_C = 0$ | | 10 | μA |

ON CHARACTERISTICS

| | | | | | |
|---------------|--------------------------------------|--|----------------|-----|---|
| h_{FE} | DC Current Gain | $I_C = 5.0 \text{ mA}, V_{CE} = 2.0 \text{ V}$ $I_C = 150 \text{ mA}, V_{CE} = 2.0 \text{ V}$ $I_C = 500 \text{ mA}, V_{CE} = 2.0 \text{ V}$ | 25 40 25 | 250 | |
| $V_{CE(sat)}$ | Collector-Emitter Saturation Voltage | $I_C = 500 \text{ mA}, I_B = 50 \text{ mA}$ | | 0.5 | V |
| $V_{BE(on)}$ | Base-Emitter On Voltage | $I_C = 500 \text{ mA}, V_{CE} = 2.0 \text{ V}$ | | 1.0 | V |

SOT-223 Tape and Reel Data and Package Dimensions



SOT-223 Packaging Configuration: Figure 1.0

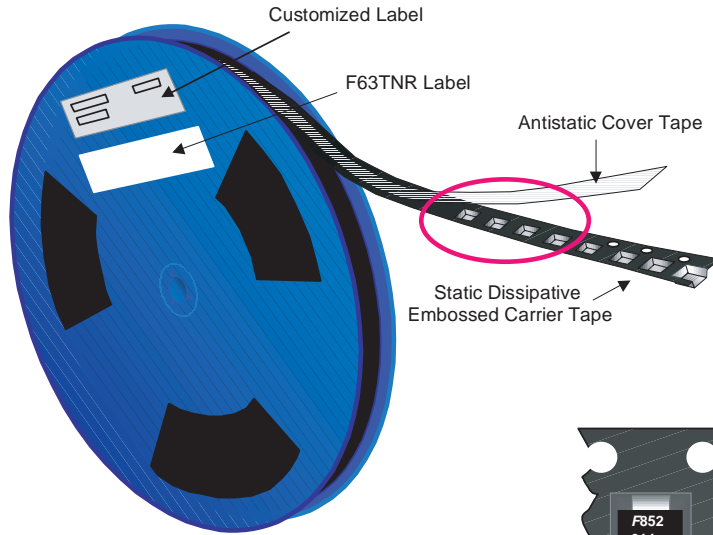

Packaging Description:
 SOT-223 parts are shipped in tape. The carrier tape is made from a dissipative (carbon filled) polycarbonate resin. The cover tape is a multilayer film (Heat Activated Adhesive in nature) primarily composed of polyester film, adhesive layer, sealant, and anti-static sprayed agent. These reeled parts in standard option are shipped with 2,500 units per 13" or 330cm diameter reel. The reels are dark blue in color and is made of polystyrene plastic (anti-static coated). Other option comes in 500 units per 7" or 177cm diameter reel. This and some other options are further described in the Packaging Information table.
 These full reels are individually barcode labeled and placed inside a standard intermediate box (illustrated in figure 1.0) made of recyclable corrugated brown paper. One box contains two reels maximum. And these boxes are placed inside a barcode labeled shipping box which comes in different sizes depending on the number of parts shipped.

| SOT-223 Packaging Information | | |
|-------------------------------|-------------------------|------------|
| Packaging Option | Standard (no flow code) | D84Z |
| Packaging type | TNR | TNR |
| Qty per Reel/Tube/Bag | 2,500 | 500 |
| Reel Size | 13" Dia | 7" Dia |
| Box Dimension (mm) | 343x64x343 | 184x187x47 |
| Max qty per Box | 5,000 | 1,000 |
| Weight per unit (gm) | 0.1246 | 0.1246 |
| Weight per Reel (kg) | 0.7250 | 0.1532 |
| Note/Comments | | |

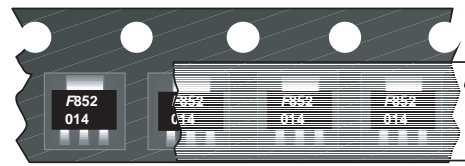

SOT-223 Unit Orientation

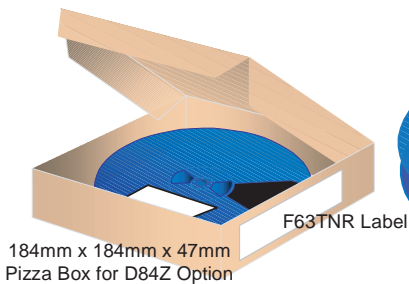
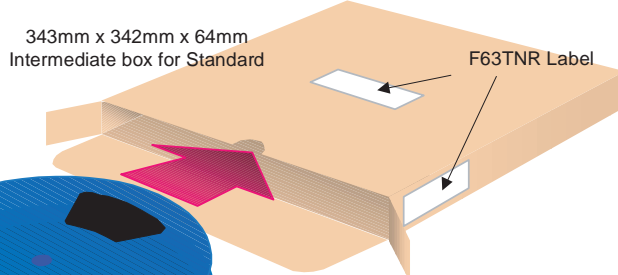

F63TNR Label sample

| | |
|------------------|-----------|
| LOT: CBVK741B019 | QTY: 3000 |
| FSID: PN2222A | SPEC: |
| | |
| D/C1: D984Z | QTY1: |
| D/C2: | QTY2: |
| SPEC REV: CPN: | N/F: F |
| (F63TNR)3 | |

SOT-223 Tape Leader and Trailer Configuration: Figure 2.0

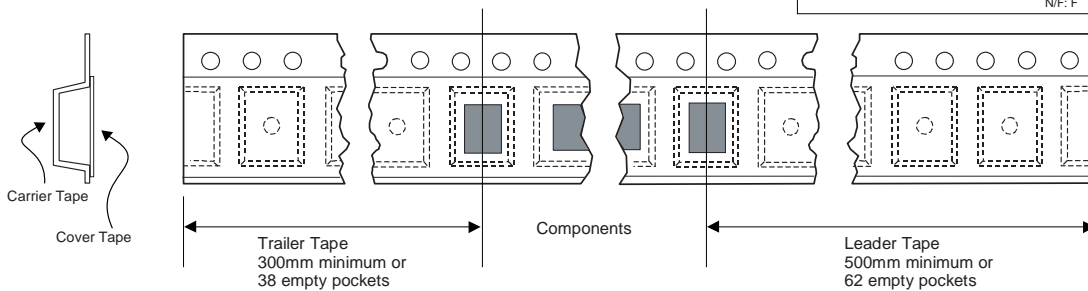

SOT-223 Tape and Reel Data and Package Dimensions, continued

SOT-223 Embossed Carrier Tape Configuration: Figure 3.0

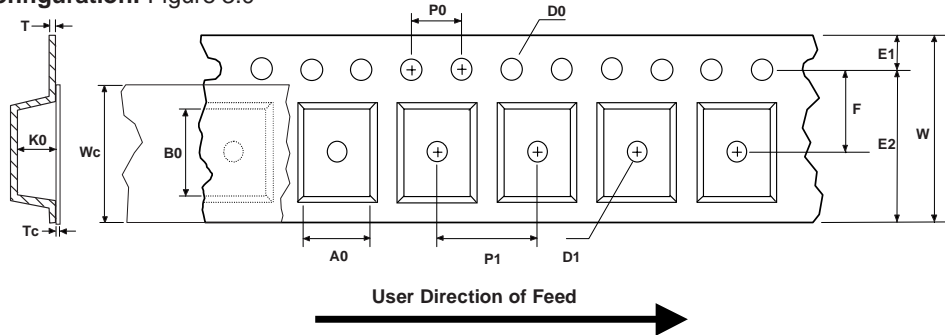

Dimensions are in millimeter

| Pkg type | A0 | B0 | W | D0 | D1 | E1 | E2 | F | P1 | P0 | K0 | T | Wc | Tc |
|-------------------|-----------------|-----------------|----------------|-----------------|-----------------|-----------------|--------------|-----------------|---------------|---------------|-----------------|------------------------|-----------------|-----------------|
| SOT-223 (12mm) | 6.83 +/-0.10 | 7.42 +/-0.10 | 12.0 +/-0.3 | 1.55 +/-0.05 | 1.50 +/-0.10 | 1.75 +/-0.10 | 10.25 min | 5.50 +/-0.05 | 8.0 +/-0.1 | 4.0 +/-0.1 | 1.88 +/-0.10 | 0.292 +/- 0.0130 | 9.5 +/-0.025 | 0.06 +/-0.02 |

Notes: A0, B0, and K0 dimensions are determined with respect to the EIA/Jedec RS-481 rotational and lateral movement requirements (see sketches A, B, and C).

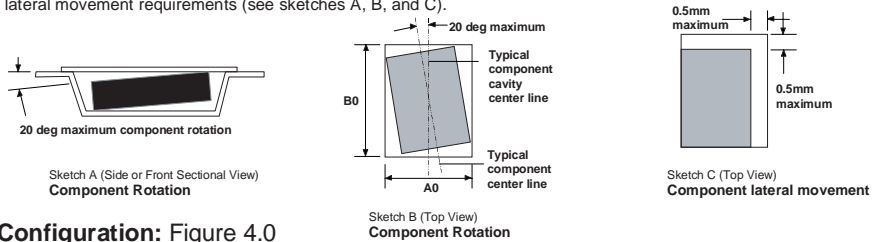

SOT-223 Reel Configuration: Figure 4.0

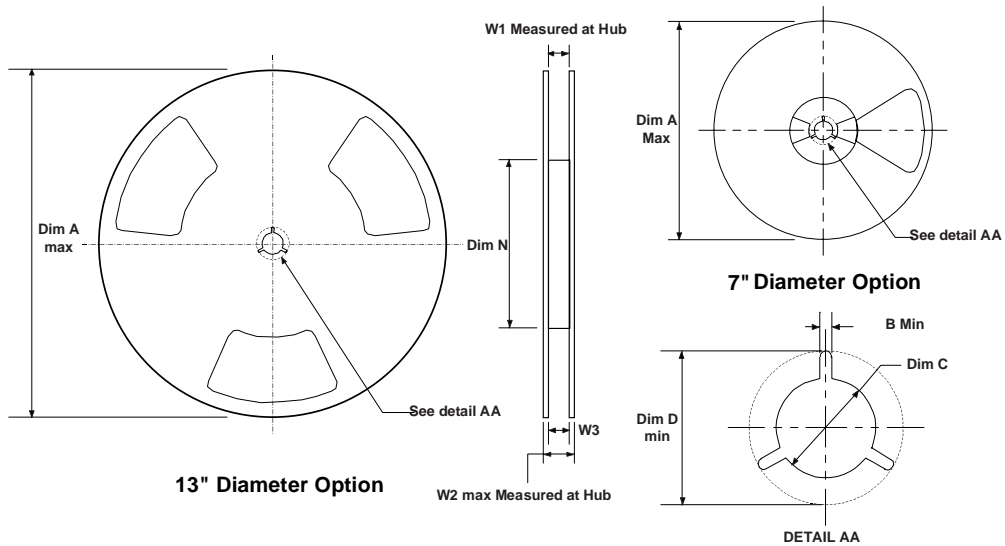

Dimensions are in inches and millimeters

| Tape Size | Reel Option | Dim A | Dim B | Dim C | Dim D | Dim N | Dim W1 | Dim W2 | Dim W3 (LSL-USL) |
|-----------|-------------|---------------|--------------|-----------------------------------|---------------|--------------|----------------------------------|---------------|------------------------------|
| 12mm | 7" Dia | 7.00 177.8 | 0.059 1.5 | 512 +0.020/-0.008 13 +0.5/-0.2 | 0.795 20.2 | 5.906 150 | 0.488 +0.078/-0.000 12.4 +2/0 | 0.724 18.4 | 0.469 - 0.606 11.9 - 15.4 |
| 12mm | 13" Dia | 13.00 330 | 0.059 1.5 | 512 +0.020/-0.008 13 +0.5/-0.2 | 0.795 20.2 | 7.00 178 | 0.488 +0.078/-0.000 12.4 +2/0 | 0.724 18.4 | 0.469 - 0.606 11.9 - 15.4 |

SOT-223 Tape and Reel Data and Package Dimensions, continued

SOT-223 (FS PKG Code 47)

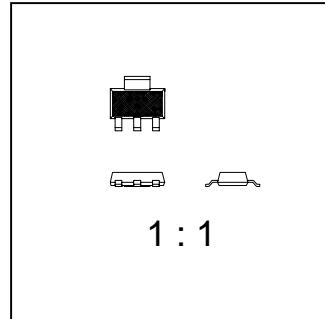
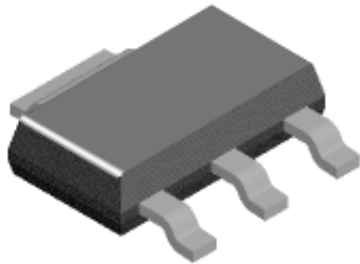

Scale 1:1 on letter size paper

Part Weight per unit (gram): 0.1246

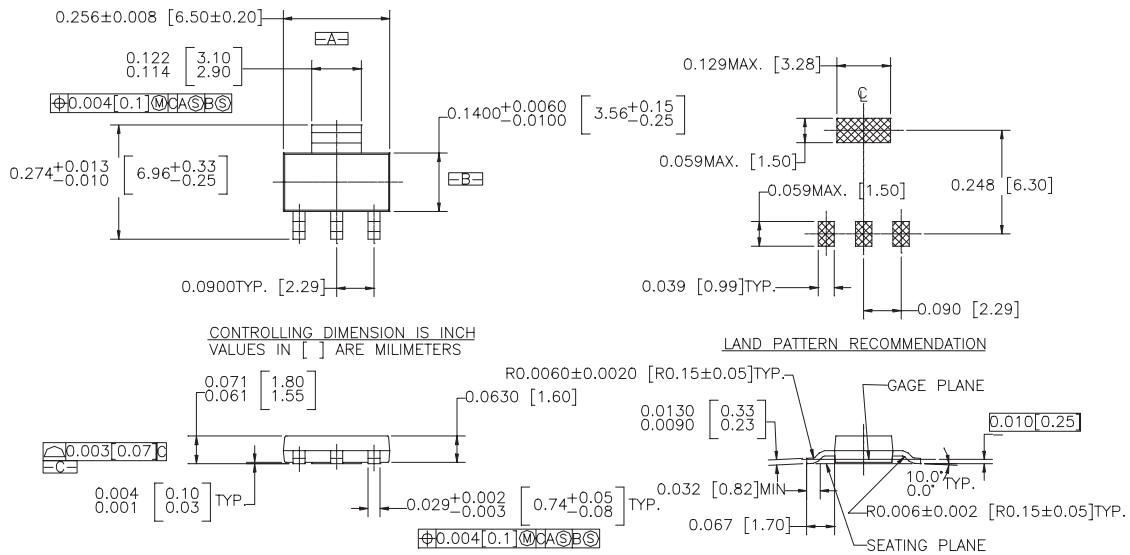

- NOTES : UNLESS OTHERWISE SPECIFIED
 1. STANDARD LEAD FINISH TO BE 150 MICRONS/ 3.81 MICROMETERS MINIMUM TIN/LEAD (SOLDER) ON COPPER.
 2. REFERENCE JEDEC REGISTRATION TO-261, VARIATION AA, ISSUE A, DATED JAN 1990

SOT223, 4 LEADS

TRADEMARKS

The following are registered and unregistered trademarks Fairchild Semiconductor owns or is authorized to use and is not intended to be an exhaustive list of all such trademarks.

| | | |
|----------------------|---------------|-------------|
| ACEx™ | HiSeC™ | SuperSOT™-8 |
| Bottomless™ | ISOPLANAR™ | SyncFET™ |
| CoolFET™ | MICROWIRE™ | TinyLogic™ |
| CROSSVOLT™ | POP™ | UHC™ |
| E ² CMOS™ | PowerTrench® | VCX™ |
| FACT™ | QFET™ | |
| FACT Quiet Series™ | QS™ | |
| FAST® | Quiet Series™ | |
| FASTr™ | SuperSOT™-3 | |
| GTO™ | SuperSOT™-6 | |

DISCLAIMER

FAIRCHILD SEMICONDUCTOR RESERVES THE RIGHT TO MAKE CHANGES WITHOUT FURTHER NOTICE TO ANY PRODUCTS HEREIN TO IMPROVE RELIABILITY, FUNCTION OR DESIGN. FAIRCHILD DOES NOT ASSUME ANY LIABILITY ARISING OUT OF THE APPLICATION OR USE OF ANY PRODUCT OR CIRCUIT DESCRIBED HEREIN; NEITHER DOES IT CONVEY ANY LICENSE UNDER ITS PATENT RIGHTS, NOR THE RIGHTS OF OTHERS.

LIFE SUPPORT POLICY

FAIRCHILD'S PRODUCTS ARE NOT AUTHORIZED FOR USE AS CRITICAL COMPONENTS IN LIFE SUPPORT DEVICES OR SYSTEMS WITHOUT THE EXPRESS WRITTEN APPROVAL OF FAIRCHILD SEMICONDUCTOR CORPORATION. As used herein:

1. Life support devices or systems are devices or systems which, (a) are intended for surgical implant into the body, or (b) support or sustain life, or (c) whose failure to perform when properly used in accordance with instructions for use provided in the labeling, can be reasonably expected to result in significant injury to the user.
2. A critical component is any component of a life support device or system whose failure to perform can be reasonably expected to cause the failure of the life support device or system, or to affect its safety or effectiveness.

PRODUCT STATUS DEFINITIONS

Definition of Terms

| Datasheet Identification | Product Status | Definition |
|--------------------------|------------------------|---|
| Advance Information | Formative or In Design | This datasheet contains the design specifications for product development. Specifications may change in any manner without notice. |
| Preliminary | First Production | This datasheet contains preliminary data, and supplementary data will be published at a later date. Fairchild Semiconductor reserves the right to make changes at any time without notice in order to improve design. |
| No Identification Needed | Full Production | This datasheet contains final specifications. Fairchild Semiconductor reserves the right to make changes at any time without notice in order to improve design. |
| Obsolete | Not In Production | This datasheet contains specifications on a product that has been discontinued by Fairchild semiconductor. The datasheet is printed for reference information only. |